

# 13 Pent Garden Shed

## Instruction Manual

4ft and 6ft wide

4ft to 20ft deep



# 13 Instruction Manual

Please follow the instructions for safe unpacking of your garden building

## Base.

Ensure the base is level and is built on firm ground, to prevent distortion. The base should be slightly smaller than the external measurement of the building to allow water to run away freely, i.e. the cladding should overlap the base. When constructing your base, remember not to build it too close to walls, fences, trees or overhanging bushes as this may cause issues with water ingress over a long period.

## Timber Information.

As timber is a natural product it is prone to changes in appearance during different weather conditions, including swelling, warping and splitting. Whilst every effort is made to hand pick timber to avoid splits and knothole, there may be instances where the timber has shrunk and small knots may have fallen out, or a small split may have appeared.

Unfortunately, we can not take responsibility for the seasoning of the timber, but we can give helpful advice on how to treat the issue. None of the mentioned instances will affect the structural integrity of the product.

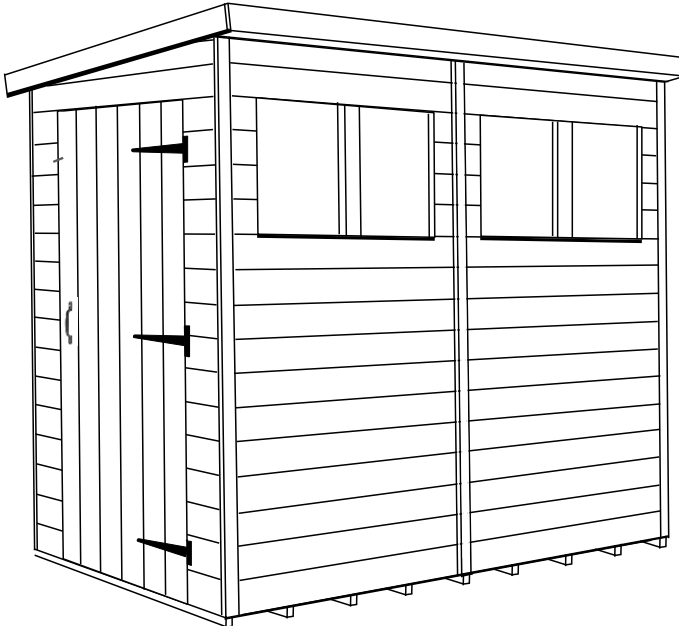
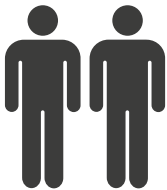

Image for illustration purposes only, your shed may vary



## Warning

Please follow the instructions for safe unpacking of your garden building







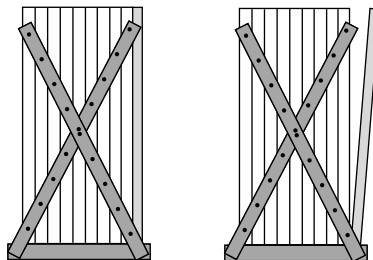









## Two people required

- Please read through the instructions before attempting to build the product.
- Position the pallet on firm level ground
- Cut the plastic banding
- Unpack the pallet by removing the screws from one panel at a time as shown.
- Empire Sheds cannot take responsibility for your safety while handling this product.



# 13 Parts Checklist

		4x4	6x4	8x4	10x4	12x4	14x4	16x4	18x4	20x4	4x6	6x6	8x6	10x6	12x6	14x6	16x6	18x6	20x6
4x6ft floor		0	0	0	0	0	0	0	0	0	1	1	2	2	3	3	4	4	5
2x6ft floor		0	0	0	0	0	0	0	0	0	0	1	0	1	0	1	0	1	0
4x4ft floor		1	1	2	2	3	3	4	4	5	0	0	0	0	0	0	0	0	0
2x4ft floor		0	1	0	1	0	1	0	1	0	0	0	0	0	0	0	0	0	0
2ft blank panel		2	2	3	3	4	4	5	5	6	2	2	3	3	4	4	5	5	6
4ft blank panel		0	2	0	2	0	2	0	2	0	2	4	2	4	2	4	2	4	2
2ft widow panel		1	1	2	2	3	3	4	4	5	1	1	2	2	3	3	4	4	5
4ft door panel		1	1	1	1	1	1	1	1	1	1	1	1	1	1	1	1	1	1
4ft Roof panel		0	0	0	0	0	0	0	0	0	1	1	2	2	3	3	4	4	5
2ft Roof panel for 6ft wide		0	0	0	0	0	0	0	0	0	0	1	0	1	0	1	0	1	0
Roof panel for 4ft wide		1	1	2	2	3	3	4	4	5	0	0	0	0	0	0	0	0	0
2ft roof panel for 4ft wide		0	1	0	1	0	1	0	1	0	0	0	0	0	0	0	0	0	0
2ft front top panel		0	1	0	1	0	1	0	1	0	0	1	0	1	0	1	0	1	0
4ft front top panel		1	1	2	2	3	3	4	4	5	1	1	2	2	3	3	4	4	5

		4x4	6x4	8x4	10x4	12x4	14x4	16x4	18x4	20x4	4x6	6x6	8x6	10x6	12x6	14x6	16x6	18x6	20x6
Gable top (6ft)		0	0	0	0	0	0	0	0	0	2	2	2	2	2	2	2	2	2
Gable top (4ft)		2	2	2	2	2	2	2	2	2	0	0	0	0	0	0	0	0	0
Barge-board (4ft)		6	2	10	6	14	10	18	2	22	20	0	8	4	0	8	16	0	20
Barge-board (6ft)		0	4	0	4	0	4	0	12	0	2	6	2	6	10	6	2	14	2
Cover strip (short)		2	3	3	4	4	5	5	6	6	4	5	5	6	6	7	7	8	8
Cover strip (long)		2	3	3	4	4	5	5	6	6	2	3	3	4	4	5	5	6	6
Heavy duty bearer (For 6ft)		0	0	0	0	0	0	0	0	0	2	2	2	2	2	2	2	2	2
Heavy duty bearer (For 4ft)		2	2	2	2	2	2	2	2	2	0	0	0	0	0	0	0	0	0
Felt		1	1	1	1	1	1	1	1	1	1	1	1	1	1	1	1	1	1
Fixing Pack		1	1	1	1	1	1	1	1	1	1	1	1	1	1	1	1	1	1

# 1. Floor Section

---

The **floor and floor bearers** are supplied separately.  
The **roof** is supplied with batons already attached.

## Step 1.

Starting with the floor panels laid upside down, screw the panels together using 3 × 50mm screws in each join.

## Step 2.

Turn the floor over so that it is the correct way up and attach the 2 heavy duty floor bearers as shown below. These must sit flush with the floorboards.

## Step 3.

Lay the completed floor in the desired location and think about where you want to position the walls.  
The gable walls (Panels which have the triangles on top) will sit on top of the heavy duty bearers.

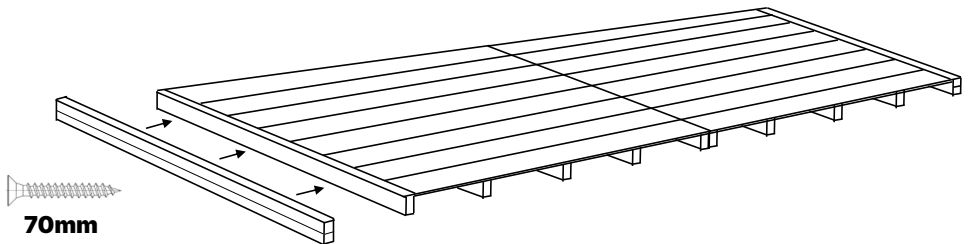

## 2. Door

### Step 1.

Lie the door or doors into the door frame on a flat surface with the cladding facing upwards. Take one T hinge and position on the door as shown below, making sure that the T hinge is directly above the brace on the underside of the door. Fix the T hinge into place with the 25mm screws. Repeat for the remaining T hinges. With the T hinges secured, position the door squarely in the door frame. Fix the top hinge first with 1 screw and the bottom hinge second with the 25mm screws. Make sure that the door can open and close freely and then fix the remaining screws into the hinges.

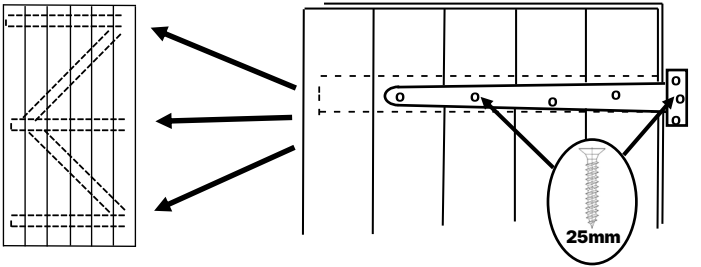
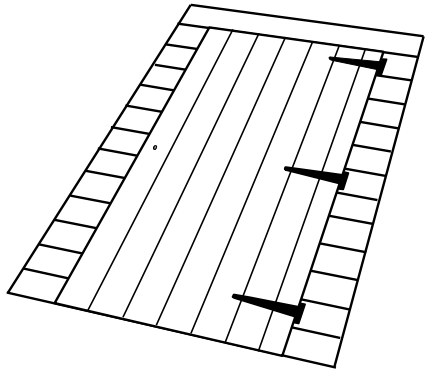

### Step 2.

Fix the turn button in place close to the top of the door. Don't screw in too tightly or it won't turn.

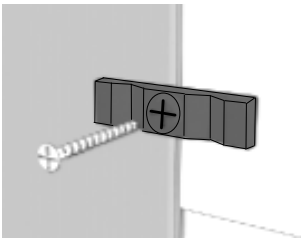

### Step 3.

On the inside of the door, line up the lock with the pre-drilled hole in the door and fix in place with the screws.

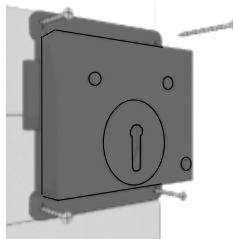

## 3. Wall Panels

---

### Step 1.

Pick out one of the 4ft panels that will be part of the gable end of your shed and place this on top of one of the heavy-duty floor bearers and line it up so that it is flush with the side of the floor.

### Step 2.

If you have a 6ft wide shed, you will need to position one of the 2ft side panels next to the 4ft panel to make up the 6ft gable end. Screw these two panels together on the in-side of the shed using 3 × 50mm screws

### Step 3.

Fix the remaining wall panels together in your desired layout using the same method.

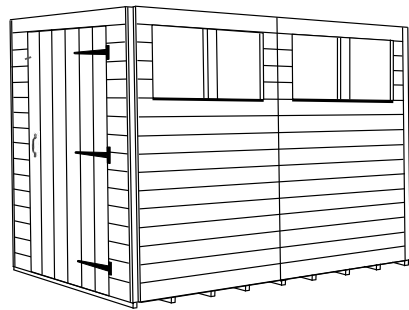
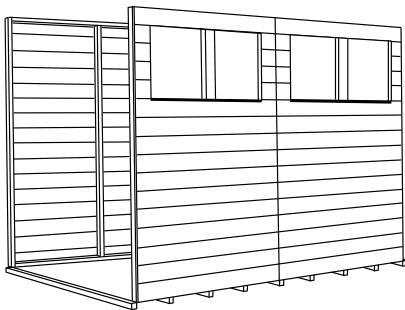
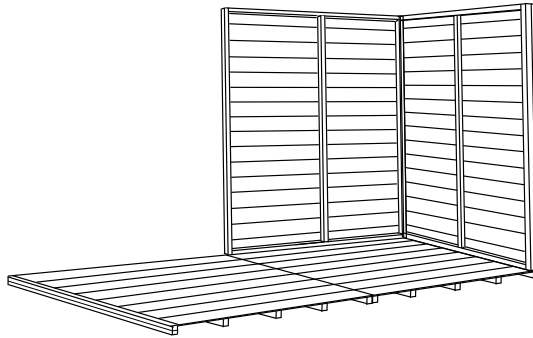

### Step 4.

Once all of the side panels are fixed together you can then attach the sides to the floor by screwing through the bottom internal frame into the floor panel, using 70mm screws.

## 4. Front and Top Gables

### Step 1.

Choose which side of the shed you wish to be taller and then fix the pent top panels in place using 50mm screws as shown below.

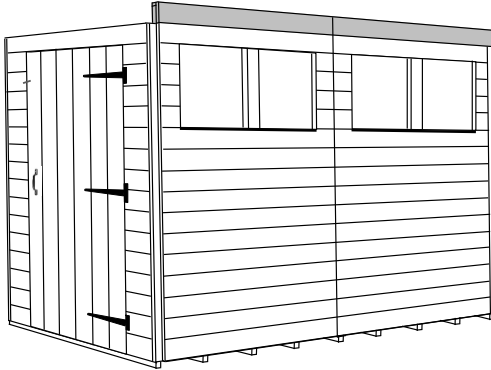

### Step 2.

Attach the gable tops to the gable end panels (the panels which are on the heavy-duty bearers) by screwing up through the internal framing using 50mm screws. Make sure that they are flush with the front and back of the panel.

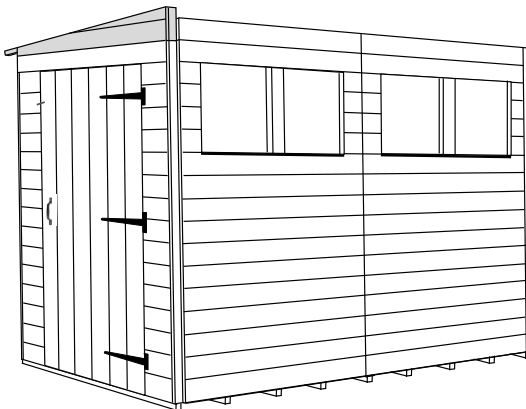

## 5. Roof

---

### Step 1.

Depending on the size of the building that you have purchased, your roof will consist of 2ft wide or 4ft wide roof panels. Position the roof panels in place so that the framing on the roof panel runs from the high side of the shed to the low side. Make sure that the front and back of the roof panels are flush with the framing on the front and back of the gable tops.

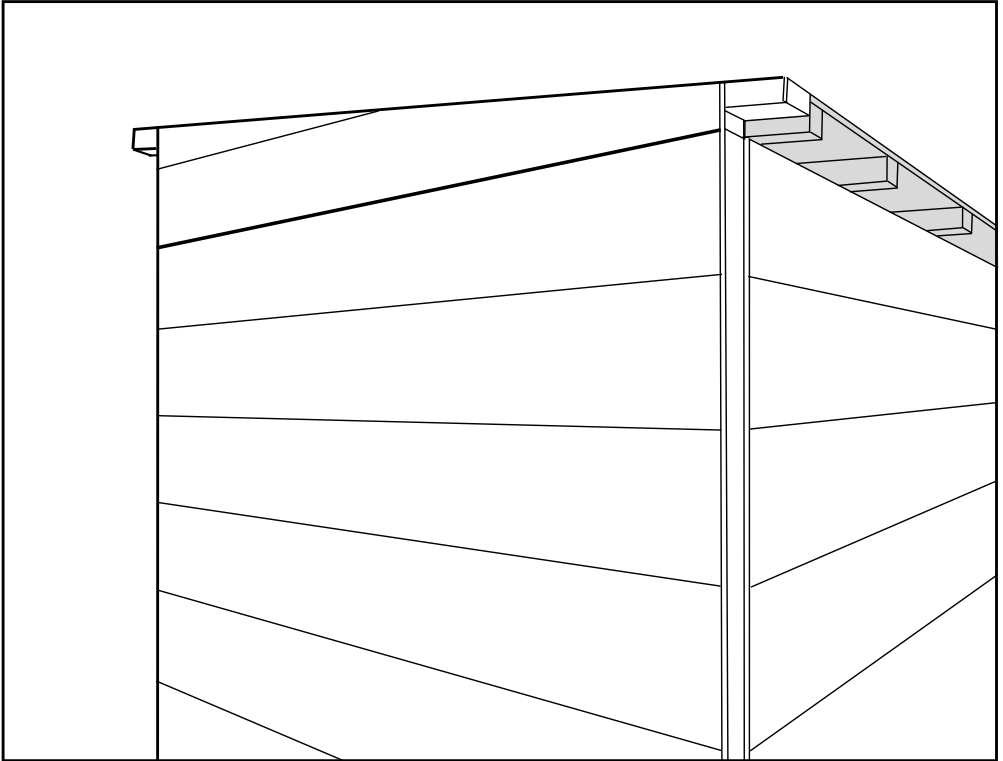

### Step 2.

Join the roof boards together and to the gable ends using 50mm screws.

### Step 3.

Fix the roof panels to the side panels by screwing up through the side panel framing into the roof uprights, using 50mm screws.

## 6. Felt

---

### Step 1.

Attach the rear barge boards to the back of the roof and the underside of the roof as shown using the 40mm nails. These fascia boards may come in more than one sections and need cutting down to size with a saw, depending on the size of shed that you have. Make sure that you use the wider strips of wood, as the narrower ones are the corner cover strips, to be attached later.

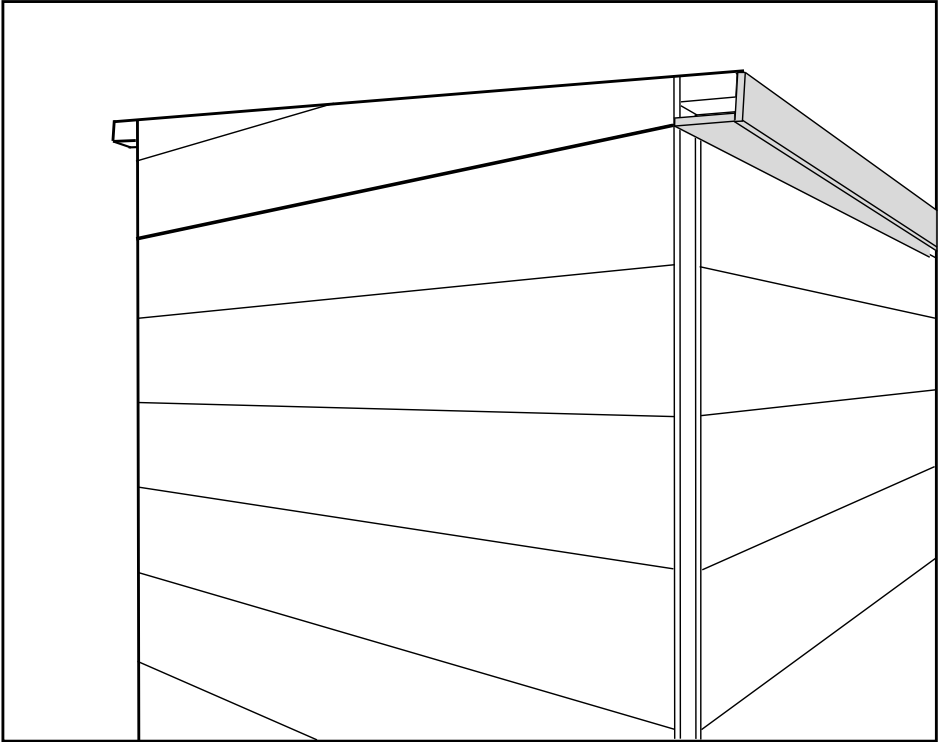

Use step Ladders when nailing the felt on to the roof, **do not climb on top of the roof** as it is not designed to hold the weight of a person.

### Step 1

Starting with the lower part of the roof using 13mm nails, attach the felt to the roof ensuring there is a 30mm overhang around the sides. Do not cover the underside roof bargeboard with felt. See below.

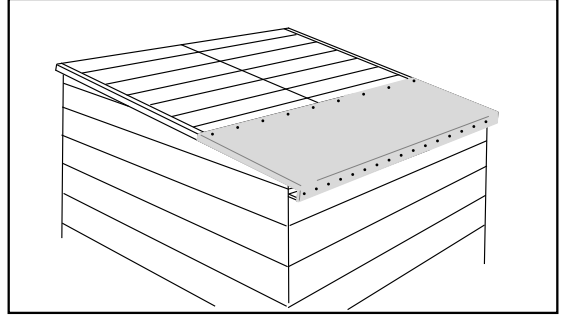

### Step 2

Lay the remaining pieces of felt onto the roof as shown, ensuring that each piece overlaps the previous piece by at least 20cm.

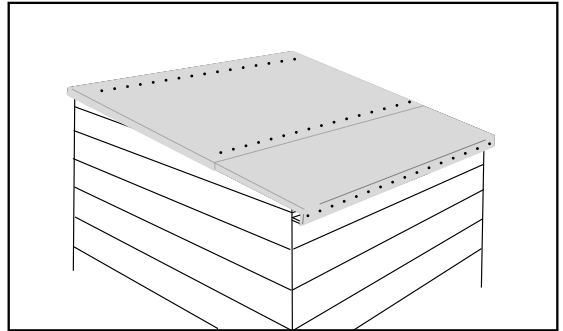

## 7. Trim

### Step 1

Using the 40mm nails attach the barge boards to the front and sides of the roof as shown. You may need to cut down the barge boards to fit, depending on the size of building that you have.

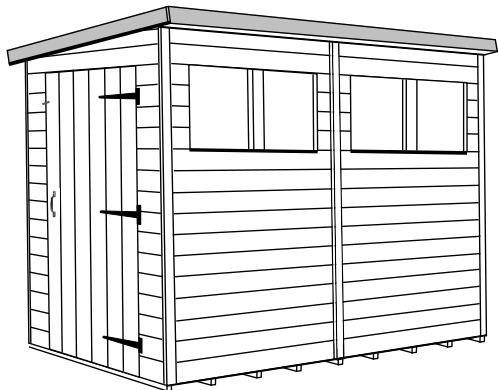

## Step 2

Attach the soffit to the underside of the roof in the same way. Again, these will need trimming to size.

Note: there will be a gap left between the front panel and the soffit to allow moisture to escape from the shed and prevent damp.

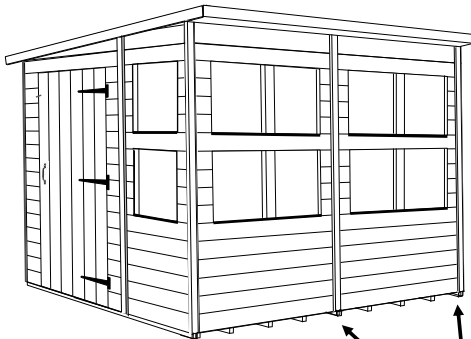
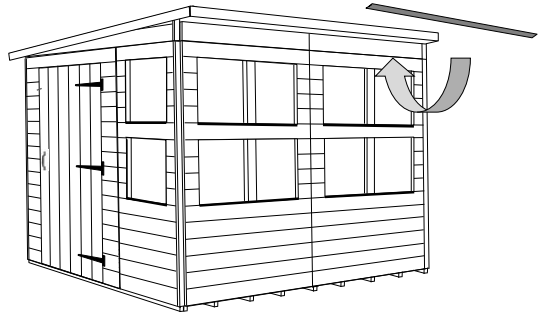

## Step 3

Finally, attach the cover trim to all corners and all joints between panels using 4x 40mm nails for each strip, as shown. Again these may need trim-ming to size

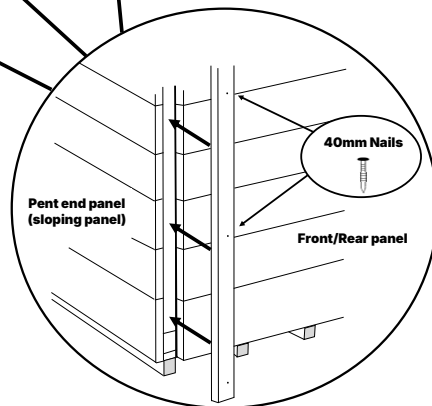

40mm Nails

## 8. Windows

The glazing for the windows is already fitted, but we recommend applying a bead of waterproof sealant (not supplied) around the outside edge of the window to help prevent water ingress



If you have any questions or queries during the assembly of your building please contact us:



**Helpline: 01384 897257**

Opening hours: Monday – Friday 9am – 4.30pm



Scan the QR code above or visit

[www.empiresheds.co.uk](http://www.empiresheds.co.uk)