

11 Apex Potting Sheds

Instruction Manual

6ft wide

6ft to 20ft deep



11 Instruction Manual

Please follow the instructions for safe unpacking of your garden building

Base.

Ensure the base is level and is built on firm ground, to prevent distortion. The base should be slightly smaller than the external measurement of the building to allow water to run away freely, i.e. the cladding should overlap the base. When constructing your base, remember not to build it too close to walls, fences, trees or overhanging bushes as this may cause issues with water ingress over a long period.

Timber Information.

As timber is a natural product it is prone to changes in appearance during different weather conditions, including swelling, warping and splitting. Whilst every effort is made to hand pick timber to avoid splits and knot holes, there may be instances where the timber has shrunk and small knots may have fallen out, or a small split may have appeared.

Unfortunately, we can not take responsibility for the seasoning of the timber, but we can give helpful advice on how to treat the issue. None of the mentioned instances will affect the structural integrity of the product.

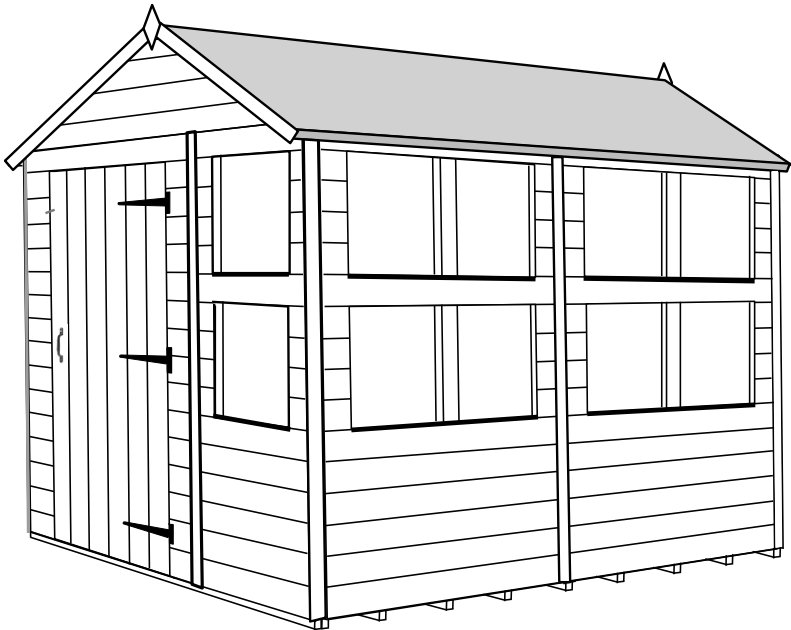
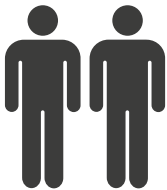

Image for illustration purposes only, your shed may vary



Warning

Please follow the instructions for safe unpacking of your garden building







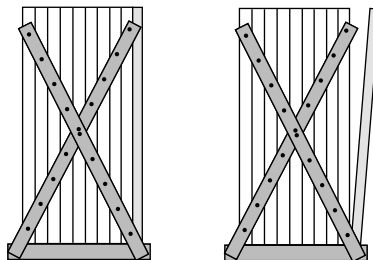















Two people required

- Please read through the instructions before attempting to build the product.
- Position the pallet on firm level ground
- Cut the plastic banding
- Unpack the pallet by removing the screws from one panel at a time as shown.
- Empire Sheds cannot take responsibility for your safety while handling this product.



11 Parts Checklist

		6×6	8×6	10×6	12×6	14×6	16×6	18×6	20×6
4×6ft Floor		0	0	0	0	0	0	0	0
2×6ft Floor		0	0	0	0	0	0	0	0
4ft Blank Panel		1	1	2	2	3	3	4	0
2ft Blank Panel		0	1	0	1	0	1	0	0
2ft Window Panel		2	2	3	3	4	4	5	6
4ft Window Panel		0	2	0	2	0	2	0	2
4ft Door Panel		1	1	2	2	3	3	4	5
4ft Roof Panel (for 6ft wide)		1	1	1	1	1	1	1	1
2ft Roof Panel (for 6ft wide)		0	0	0	0	0	0	0	10
6ft Heavy Duty Bearer		0	0	0	0	0	0	0	0
4×2ft Potting Shed Shelf		2	2	4	4	6	6	8	0
6×2ft Potting Shed Shelf		0	2	0	2	0	2	0	0
Potting Shed Shelf Upright		0	0	0	0	0	0	0	2

		6×6	8×6	10×6	12×6	14×6	16×6	18×6	20×6
Roof Truss 6ft		1	1	2	2	3	3	4	4
Gable Top 6ft		2	2	2	2	2	2	2	2
Final		2	2	2	2	2	2	2	2
Bargeboard 6ft		4	4	4	4	4	4	4	4
Cover Strip		8	8	10	10	12	12	14	14
Felt		1	1	1	1	1	1	1	1
Fixing Pack		1	1	1	1	1	1	1	1

1. Floor Section

The **floor and floor bearers** are supplied separately.
The **roof** is supplied with batons already attached.

Step 1.

Starting with the floor panels laid upside down, screw the panels together using 3 × 50mm screws in each join.

Step 2.

Turn the floor over so that it is the correct way up and attach the 2 heavy duty floor bearers as shown below. These must sit flush with the floorboards.

Step 3.

Lay the completed floor in the desired location and think about where you want to position the walls. The gable walls (Panels which have the triangles on top) will sit on top of the heavy duty bearers.

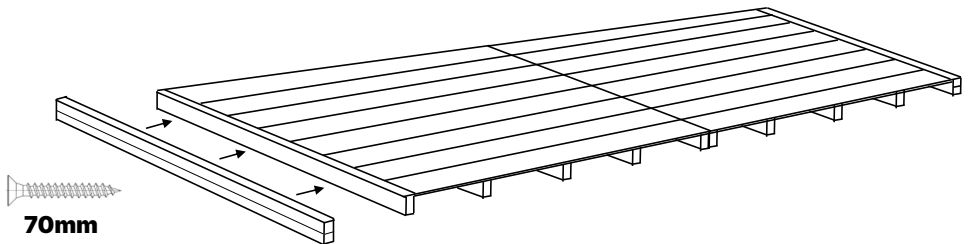

2. Door

Step 1.

Lie the door or doors into the door frame on a flat surface with the cladding facing upwards. Take one T hinge and position on the door as shown below, making sure that the T hinge is directly above the brace on the underside of the door. Fix the T hinge into place with the 25mm screws. Repeat for the remaining T hinges. With the T hinges secured, position the door squarely in the door frame. Fix the top hinge first with 1 screw and the bottom hinge second with the 25mm screws. Make sure that the door can open and close freely and then fix the remaining screws into the hinges.

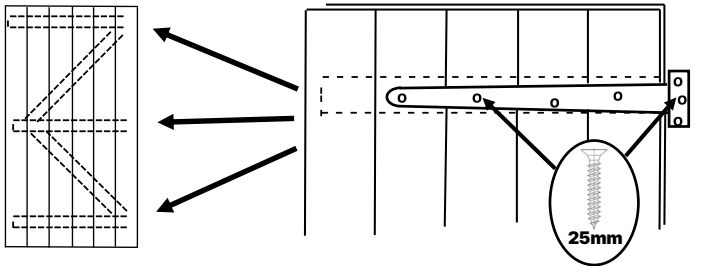
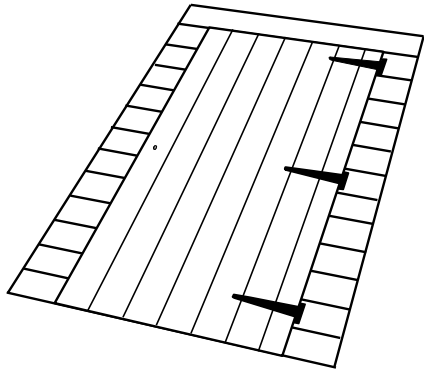

Step 2.

Fix the turn button in place close to the top of the door. Don't screw in too tightly or it won't turn.

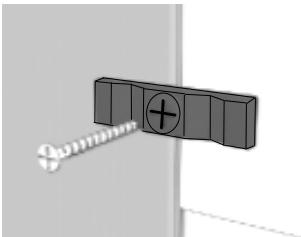

Step 3.

On the inside of the door, line up the lock with the pre-drilled hole in the door and fix in place with the screws.

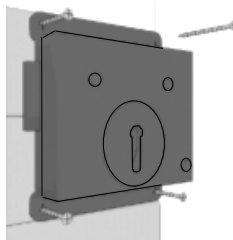

3. Wall Panels

Step 1.

Pick out one of the 4ft panels that will be part of the gable end of your shed and place this on top of one of the heavy-duty floor bearers and line it up so that it is flush with the side of the floor.

Step 2.

If you have a 6ft wide shed, you will need to position one of the 2ft side panels next to the 4ft panel to make up the 6ft gable end. Screw these two panels together on the in-side of the shed using 3 × 50mm screws

Step 3.

Fix the remaining wall panels together in your desired layout using the same method.

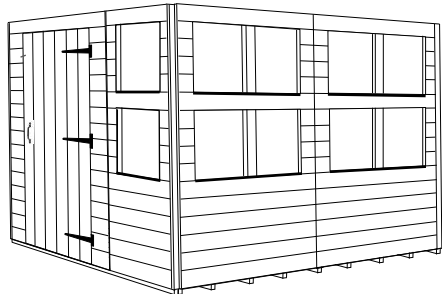
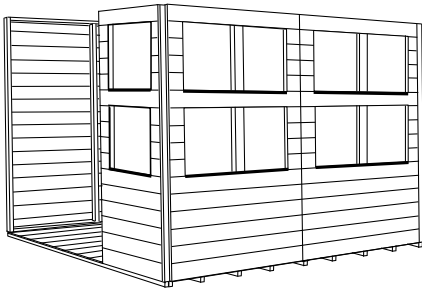
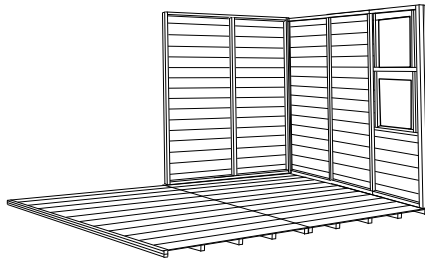
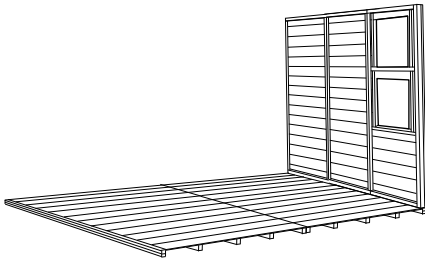

Step 4.

Once all of the side panels are fixed together you can then attach the sides to the floor by screwing through the bottom internal frame into the floor panel, using 70mm screws.

4. Front and Top Gables

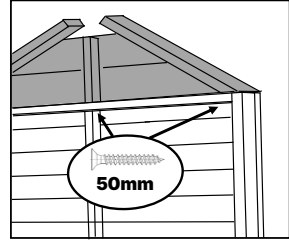
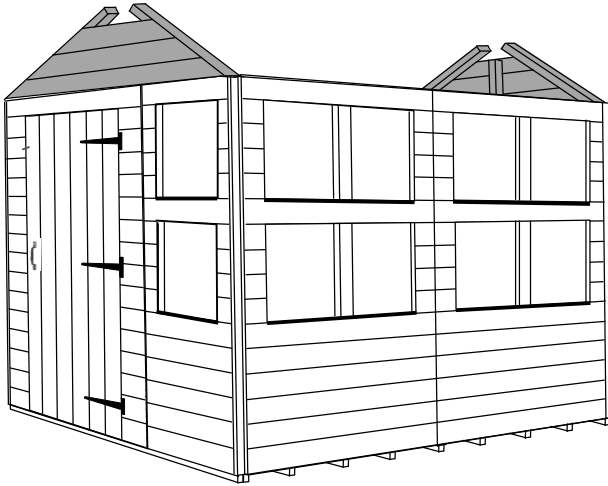

Step 1.

Attach the gable tops to the gable end panels (the panels which are on the heavy-duty bearers) by screwing up through the internal framing using 50mm screws. Make sure that they are flush with the front and back of the panel.

5. Apex Supports

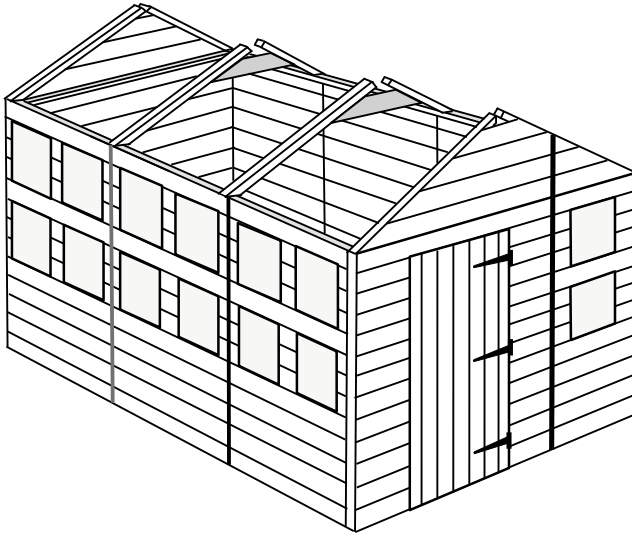

Multiple roof boards.

For sheds with multiple roof boards, attach the roof connector batons to the underside of the roof panels as shown using 50mm screws. For larger roofs 10ft and above the batons will need to be attached to both ends.

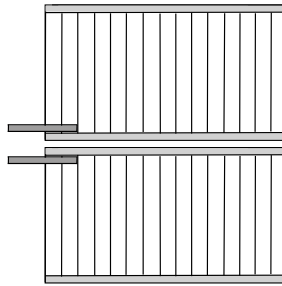

Lay the roof boards on top of the shed as shown, ensuring that the panels sit halfway across the apex roof supports, so that the next panel has space to fit onto the same support.

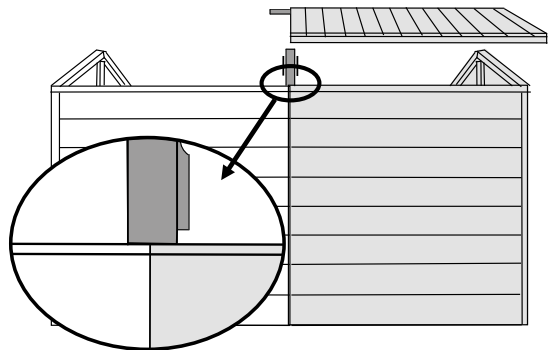

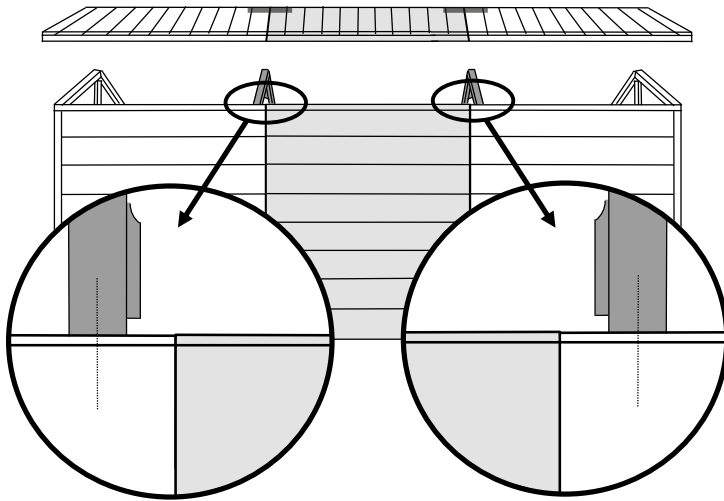

Multiple roof panels.

For sheds with more than 2 roof panels in length, position the apex supports so that the roof panels sit halfway across each support, fix with 50mm screws. Ensure that the finished roof will overhang the gable ends equally.

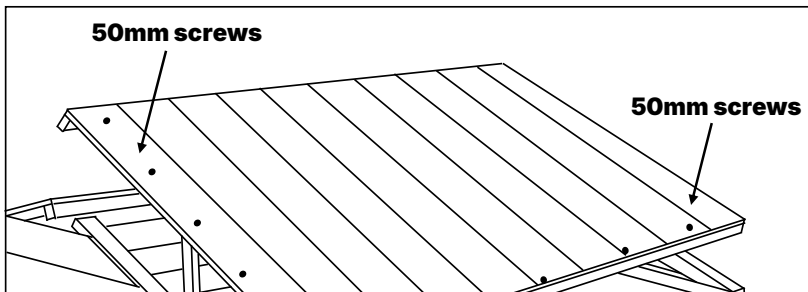

Once all of the roof boards have been placed onto the shed, screw the centre of the underside of the roof together.

Then fix the gables, roof supports and the bottom edge of the shed using the 50mm screws.

6. Roof felt

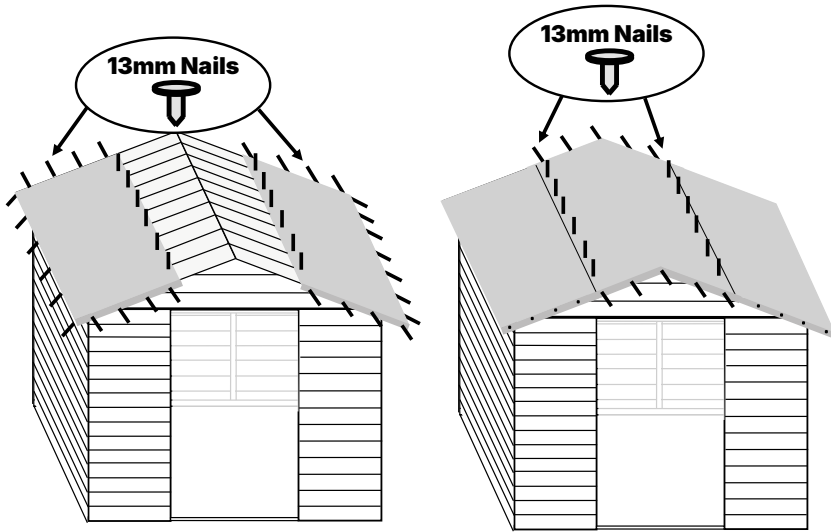

Step 1.

Starting with the lower part of the roof, attach the felt using the 13mm clout nails ensuring that there is a 30mm overhang around the edge. Next roll out and attach the centre piece of felt as shown above.

Use step Ladders when nailing the felt on to the roof, do not climb on top of the roof as it is not designed to hold the weight of a person.

Step 2.

Attach the roof trim to the front and rear of the sheds using the 40mm nails. These need to be cut down to length.

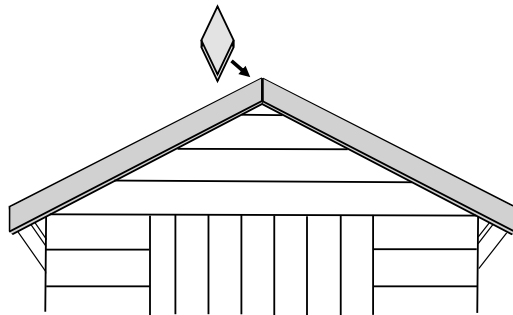

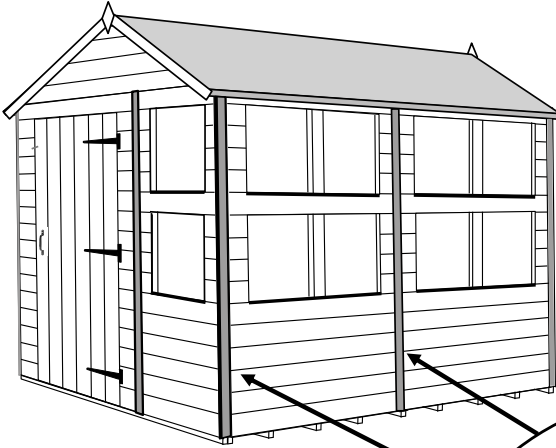

Step 3.

Finally, attach the cover trim to all corners and all joins between panels using 4× 40mm nails for each strip, as shown. Again, these will need to be cut down to the fit.

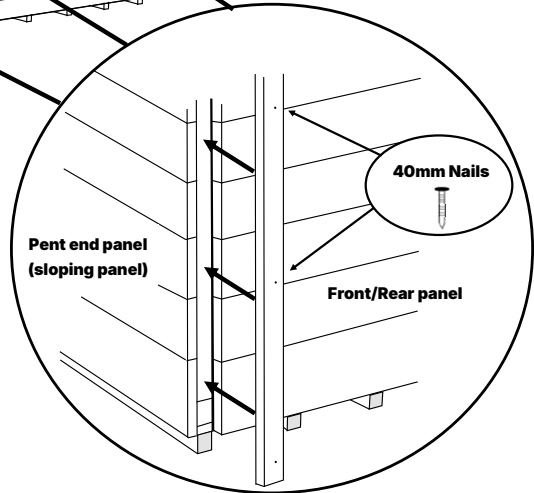

7. Windows

The glazing for the windows is already fitted , but we recommend applying a bead of waterproof sealant (not supplied) around the outside edge of the window to help prevent water ingress.

8. Assembling the staging unit

Please note:

- The staging units may need to be cut down to size depending on where you decide to position them. Make sure that they are correctly sized before erecting them.
- From the fixing pack use the 70mm screws provided to join the shelves to the framing.
- Ensure that when attaching the shelves to the shed side panels you only screw into the framing of the shed.

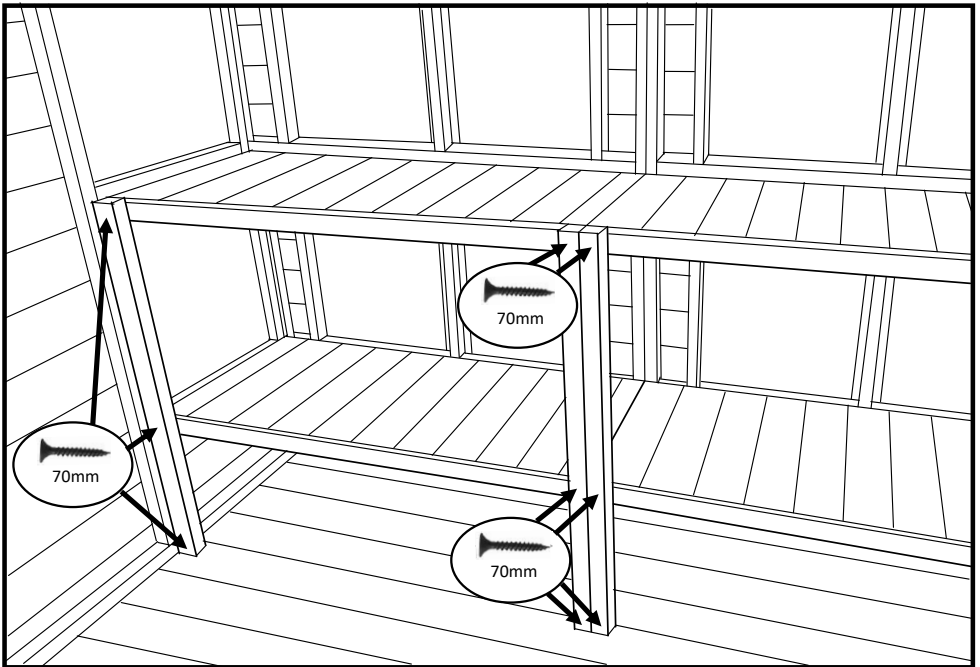

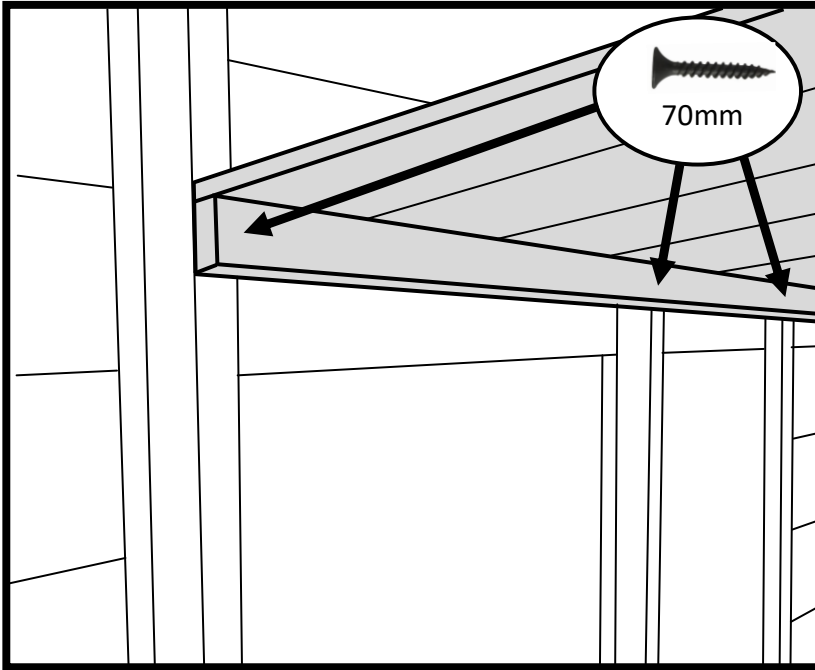

Step 1

Make sure that the shelves are level using a spirit level before screwing them together. It is best to drill a pilot hole to avoid the timber splitting.

Step 2

Once you have all of the shelves in place, screw the legs to the floor of the shed with the 70mm screws.



If you have any questions or queries during the assembly of your building please contact us:



Helpline: 01384 897257

Opening hours: Monday – Friday 9am – 4.30pm



Scan the QR code above or visit

www.empiresheds.co.uk